

Data sheet | Item number: 769-640

THT male header; 1.0 x 1.0 mm solder pin; straight; Pin spacing 5 mm; 10-pole

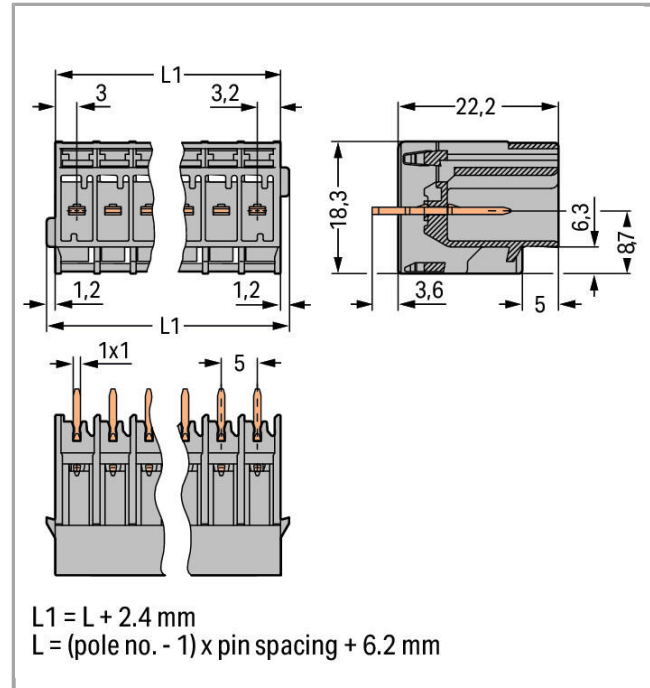

769-640



RoHS Compliant

[BOMcheck.net](https://www.bomcheck.net)

Color: ■

Data

Electrical data

Ratings per IEC/EN 60664-1

Rated voltage (III / 3)	250 V
Rated impulse voltage (III / 3)	4 kV
Rated voltage (III / 2)	500 V
Rated impulse voltage (III / 2)	4 kV
Rated current	32 A

Connection data

No. of poles	10
Total number of potentials	10

Number of levels	1
------------------	---

Geometrical Data

Pin spacing	5 mm / 0.197 inch
Width	53.6 mm / 2.11 inch
Height from the surface	22.2 mm / 0.874 inch
Depth	18.3 mm / 0.72 inch

Plug connection

Contact type (pluggable connector)	Male connector/plug
Connector connection type	for PCBs
Mismating protection	No
Mating direction to the PCB	90°

PCB contact

PCB contact	THT
-------------	-----

Material Data

Color	gray
Insulating material	Polyamide 66 (PA 66)
Fire load	0.216 MJ
Weight	10.17 g

Commercial data



Product Group	18 (X-COM-System)
Country of origin	DE
GTIN	4044918270748
Customs Tariff No.	85366990990

Approvals / Certificates



Country specific Approvals

Logo	Approval	Additional Approval Text	Certificate name
	CCA DEKRA Certification B.V.	EN 60947	NTR NL- 7626

	CCA DEKRA Certification B.V.	EN 61984	2190419.02
--	---------------------------------	----------	------------

	CCA DEKRA Certification B.V.	IEC 61984	NL-47799
	CSA DEKRA Certification B.V.	C22.2 No. 158	1101144
	KEMA/KEUR DEKRA Certification B.V.	EN 60947	2190419.01

UL-Approvals

Logo	Approval	Additional Approval Text	Certificate name
	UR Underwriters Laboratories Inc.	UL 1977	E45171
	UR Underwriters Laboratories Inc.	UL 1059	E45172

Compatible products



Coding















	Item no.: 769-435 Coding pin; for coding of female plugs; for carrier terminal blocks / male connectors	769-435
--	--	---------















Marking accessories















	Item no.: 210-831 Marking strips; on reel; 2.3 mm wide; plain; Self-adhesive	210-831
	Item no.: 210-832 Marking strips; on reel; 3 mm wide; plain; Self-adhesive	210-832
	Item no.: 210-833 Marking strips; on reel; 6 mm wide; plain; Self-adhesive	210-833
	Item no.: 210-834 Marking strips; on reel; 5 mm wide; plain; Self-adhesive	210-834

Female plug

	Item no.: 769-101 1-conductor female plug; 4 mm ² ; 1-pole	769-101
	Item no.: 769-102 1-conductor female plug; 4 mm ² ; 2-pole	769-102

	Item no.: 769-102/000-036 1-conductor female plug; 4 mm ² ; 2-pole	769-102 /000-036
	Item no.: 769-102/000-037 1-conductor female plug; 4 mm ² ; 2-pole	769-102 /000-037
	Item no.: 769-103 1-conductor female plug; 4 mm ² ; 3-pole	769-103
	Item no.: 769-103/000-036 1-conductor female plug; 4 mm ² ; 3-pole	769-103 /000-036
	Item no.: 769-103/000-037 1-conductor female plug; 4 mm ² ; 3-pole	769-103 /000-037
	Item no.: 769-103/000-038 1-conductor female plug; 4 mm ² ; 3-pole	769-103 /000-038
	Item no.: 769-103/000-039 1-conductor female plug; 4 mm ² ; 3-pole	769-103 /000-039
	Item no.: 769-104 1-conductor female plug; 4 mm ² ; 4-pole	769-104
	Item no.: 769-104/000-036 1-conductor female plug; 4 mm ² ; 4-pole	769-104 /000-036
	Item no.: 769-104/000-037 1-conductor female plug; 4 mm ² ; 4-pole	769-104 /000-037
	Item no.: 769-104/000-038 1-conductor female plug; 4 mm ² ; 4-pole	769-104 /000-038
	Item no.: 769-104/000-039 1-conductor female plug; 4 mm ² ; 4-pole	769-104 /000-039
	Item no.: 769-105 1-conductor female plug; 4 mm ² ; 5-pole	769-105
	Item no.: 769-105/000-036 1-conductor female plug; 4 mm ² ; 5-pole	769-105 /000-036
	Item no.: 769-105/000-037 1-conductor female plug; 4 mm ² ; 5-pole	769-105 /000-037

	Item no.: 769-105/000-038 1-conductor female plug; 4 mm ² ; 5-pole		769-105
		/000-038	
	Item no.: 769-105/000-039 1-conductor female plug; 4 mm ² ; 5-pole		769-105
		/000-039	
	Item no.: 769-106 1-conductor female plug; 4 mm ² ; 6-pole		769-106
	Item no.: 769-106/000-006 1-conductor female plug; 4 mm ² ; 6-pole		769-106
		/000-006	
	Item no.: 769-106/000-036 1-conductor female plug; 4 mm ² ; 6-pole		769-106
		/000-036	
	Item no.: 769-106/000-037 1-conductor female plug; 4 mm ² ; 6-pole		769-106
		/000-037	
	Item no.: 769-106/000-038 1-conductor female plug; 4 mm ² ; 6-pole		769-106
		/000-038	
	Item no.: 769-106/000-039 1-conductor female plug; 4 mm ² ; 6-pole		769-106
		/000-039	
	Item no.: 769-107 1-conductor female plug; 4 mm ² ; 7-pole		769-107
	Item no.: 769-107/000-036 1-conductor female plug; 4 mm ² ; 7-pole		769-107
		/000-036	
	Item no.: 769-107/000-037 1-conductor female plug; 4 mm ² ; 7-pole		769-107
		/000-037	
	Item no.: 769-107/000-038 1-conductor female plug; 4 mm ² ; 7-pole		769-107
		/000-038	
	Item no.: 769-107/000-039 1-conductor female plug; 4 mm ² ; 7-pole		769-107
		/000-039	
	Item no.: 769-108 1-conductor female plug; 4 mm ² ; 8-pole		769-108
	Item no.: 769-108/000-036 1-conductor female plug; 4 mm ² ; 8-pole		769-108
		/000-036	

	Item no.: 769-108/000-037 1-conductor female plug; 4 mm ² ; 8-pole		769-108
		/000-037	
	Item no.: 769-108/000-038 1-conductor female plug; 4 mm ² ; 8-pole		769-108
		/000-038	
	Item no.: 769-108/000-039 1-conductor female plug; 4 mm ² ; 8-pole		769-108
		/000-039	
	Item no.: 769-109 1-conductor female plug; 4 mm ² ; 9-pole		769-109
	Item no.: 769-109/000-036 1-conductor female plug; 4 mm ² ; 9-pole		769-109
		/000-036	
	Item no.: 769-109/000-037 1-conductor female plug; 4 mm ² ; 9-pole		769-109
		/000-037	
	Item no.: 769-109/000-038 1-conductor female plug; 4 mm ² ; 9-pole		769-109
		/000-038	
	Item no.: 769-109/000-039 1-conductor female plug; 4 mm ² ; 9-pole		769-109
		/000-039	
	Item no.: 769-110 1-conductor female plug; 4 mm ² ; 10-pole		769-110
	Item no.: 769-110/000-036 1-conductor female plug; 4 mm ² ; 10-pole		769-110
		/000-036	
	Item no.: 769-110/000-037 1-conductor female plug; 4 mm ² ; 10-pole		769-110
		/000-037	
	Item no.: 769-110/000-038 1-conductor female plug; 4 mm ² ; 10-pole		769-110
		/000-038	
	Item no.: 769-110/000-039 1-conductor female plug; 4 mm ² ; 10-pole		769-110
		/000-039	
	Item no.: 769-110/021-000 1-conductor female plug; Locking lever; 4 mm ² ; 10-pole		769-110
		/021-000	
	Item no.: 769-121 2-conductor female connector; 4 mm ² ; 1-pole		769-121

	Item no.: 769-122 2-conductor female connector; 4 mm ² ; 2-pole	769-122
	Item no.: 769-123 2-conductor female connector; 4 mm ² ; 3-pole	769-123
	Item no.: 769-124 2-conductor female connector; 4 mm ² ; 4-pole	769-124
	Item no.: 769-125 2-conductor female connector; 4 mm ² ; 5-pole	769-125
	Item no.: 769-126 2-conductor female connector; 4 mm ² ; 6-pole	769-126
	Item no.: 769-127 2-conductor female connector; 4 mm ² ; 7-pole	769-127
	Item no.: 769-128 2-conductor female connector; 4 mm ² ; 8-pole	769-128
	Item no.: 769-129 2-conductor female connector; 4 mm ² ; 9-pole	769-129
	Item no.: 769-130 2-conductor female connector; 4 mm ² ; 10-pole	769-130

Downloads

Documentation

Bid Text

769-640	doc 25.6 kB	Download
---------	----------------	----------

CAD/CAE - Smart Data

CAD data

3D Download 769-640	URL	Download
---------------------	-----	----------

Product family

X-COM

[Learn more about the product family.](#)

[Show all products from the family](#)



Subject to changes.
